



**ALARM LOCK**

345 Bayview Avenue  
Amityville, New York 11701  
For Sales and Repairs 1-800-ALA-LOCK  
For Technical Service 1-800-645-9440  
Publicly traded on NASDAQ Symbol: NSSC  
© ALARM LOCK 2006

# Trilogy

## DL3000 Programming Instructions

O1224C 9/06

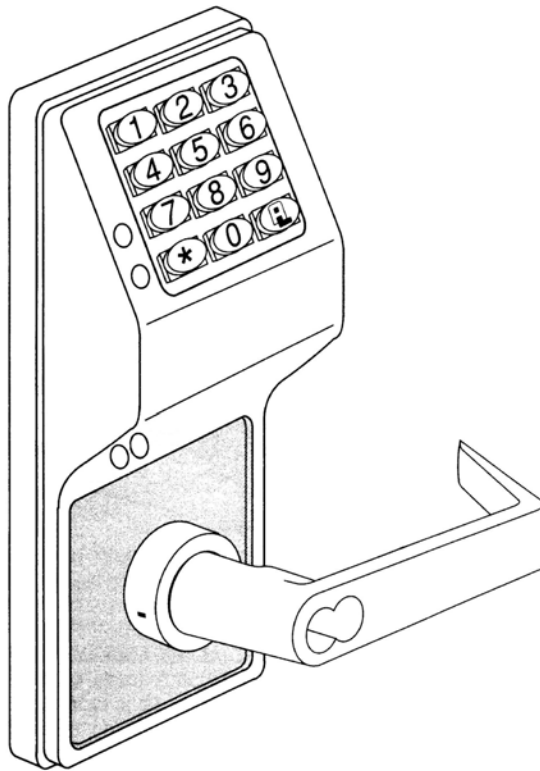

DL3000 Trilogy Series  
Standalone Access Control System

# DL3000 SERIES LOCK

THE **ALARM LOCK** TRILOGY DL-SERIES STAND-ALONE ACCESS CONTROL SYSTEM IS A SERIES OF STATE-OF-THE-ART MICROPROCESSOR-BASED PROGRAMMABLE KEYPAD-ENTRY AND PROXIMITY SECURITY LOCKS.

## DL3000

Features a real-time clock/calendar that automatically adjusts for Daylight Saving Time and allows for automated programming of events. Features three methods of programming:

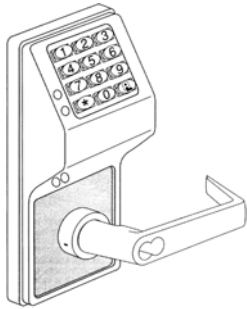

- (1) All features can be programmed manually through the keypad;
- (2) You can transfer programming instructions directly from your laptop or desktop PC using DL Windows software and a special *AL-PCI* cable; and
- (3) data can be transferred from your PC to your DL lock via the *AL DTM* handheld *Data Transfer Module*.

In addition, data can be retrieved from the lock in one of three ways (1) through an infrared printer; (2) directly from the lock to the PC; or (3) through an *AL-DTM* to your PC.

## Table of Contents

DL3000 Lock Features.....	3	Programming Functions--Overview.....	13
Supported Products .....	4	Programming Functions.....	14-26
Lock Design Overview .....	5	Groups and Scheduled Group 1 Examples .....	27-28
Quick Start .....	6	Programming Record Sheet .....	29
Terminology Used in this Manual .....	7	User Code Record Sheet.....	30
Conventions Used in this Manual .....	8	Schedule Record Sheet .....	31
Programming Levels .....	9	Glossary .....	32-33
Wiring, Power Up & Battery Replacement.....	10	ALARM LOCK LIMITED WARRANTY.....	36
LED and Sounder Indicators.....	11		
Product Communication Examples .....	12		

# DL3000 Lock Features

```
----- AUDIT LOG -----  
09/23/05 13:06:35 Fri  
13:01:59 001 PROGRAM 56  
13:01:29 001 PROGRAM 57  
13:00:53 001 ENTRY  
13:00:26 013 ENTRY  
13:00:03 012 ENTRY  
12:56:27 001 PROGRAM 2  
12:56:27 001 PROGRAM 40  
12:56:04 001 PROGRAM 39  
12:55:00 NEW CLCK TIME  
12:01:39 OLD CLCK TIME  
12:00:45 RAM TEST PASS  
12:00:45 POWER UP  
-----  
End of Audit Log
```

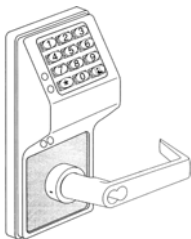

## User Features

- 300 Users
- Pre-defined Administration User Levels including *Master, Manager and Supervisor* User Codes (see page 9)
- User Code Lengths from 3-6 digits
- Service Code ("One-Time-Only" Code) (see page 8)
- User Lockout Mode (see page 15, Function 6)
- Users Assignable to 4 Groups (see page 17)
- *Ambush* Function (see page 22, Function 66)

## Lock Features

- Metal Key Override
- Keypad Lockout (see page 22, Functions 60-61)
- Non-Volatile (Fixed) Memory
- Real-Time Clock adjustable to within 1 second (see page 19, Functions 43-44)
- Programmable Relay (see page 23)
- Visual and Audible Keypad Feedback (see page 11)
- Battery Status Monitor (see page 10-11)

## Scheduling

- 150 Scheduled Events (see page 24)
- Automated Unlock/Lock
- Enable/Disable Users (see page 14, Function 3)
- Enable/Disable Groups (see page 16)
- Four "Quick Schedules" (contains 4 most common schedules) (see page 25)
- Real-time clock and calendar (see page 18)
- Programmable Timeout Functions (see page 17)

## User Access Methods

- Keypad Entered User Codes (see page 14)
- Metal Key Override

## Keypad and Computer Programming

- All programming may be performed manually from the keypad, or from a PC using Alarm Lock's DL-Windows Software (see page 8. "What is DL-Windows?")

## Audit Trail

- 1600 Event Capacity
- Entries Logged with Time and Date
- Critical Programming Events Logged
- Printable using the AL-IR1 Hand-Held Printer (see page 21, Function 55)
- Transferable using Alarm Lock's DL-Windows software (see page 21, Function 58)
- Transferable to AL-DTM

## AL-DTM Data Transfer Module

- Use Alarm Lock's AL-DTM to easily transfer program data between locks and a PC running DL-WINDOWS software. Easily transfer Audit Trail from multiple locks and then view or print each Audit Trail from a computer.

# Supported Products



## Data Transfer Module (AL-DTM)

An **AL-DTM** can be used to transfer Lock Programs (and other data) between DL-Windows and locks. When computers cannot be transported or when electrical power is not available, the hand-held **AL-DTM** device acts as a go-between—it allows the transfer of lock data from the computer (through the **AL-DTM**) and to the lock, or in reverse (from the lock through the **AL-DTM** back to the computer). Use of the older **AL-DTM model 1** is not recommended. **Note:** The latest model, the AL-DTM-III, is supported in DL-Windows version 3.5.1 or later.



## Infrared Printer (AL-IR1)

An **AL-IR1** printer is used to print Audit Trails and User Code lists without the need for a PC. Its infrared reader means no cable connection to the lock is needed.

AL-IR1 PRINTER



## AL-PCI Cable

An ALARM LOCK **AL-PCI** cable is required to communicate between your computer's RS-232 serial communications port (COM 1-4) and the **AL-DTM** or lock. One end of the **AL-PCI** cable is designed to be used on a 9-pin serial Com Port. If your computer has a 25-pin Com Port only, a 25-pin to 9-pin adapter must be used. The other end of the **AL-PCI** cable features a 2-pin banana plug connector which is polarity sensitive—the TAB (marked "GND") side must be plugged into the lock's **black** (left) terminal.

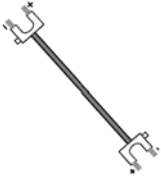

## Double-ended Mini Banana Plug Connector

After you create the program in DL-Windows and transfer the program from your computer to an **AL-DTM**, transfer the program from the **AL-DTM** to the lock(s) via a double-ended mini banana plug.



## DB9 to DB9 Serial Cable

Enroll User Codes into DL-Windows, then transfer this new User Code data from the computer to the **AL-PRE** via this 9-pin DB9 to DB9 serial cable. Once the data is in the **AL-PRE**, you can transfer the data to the lock via the double-ended mini banana plug (see above), thus avoiding the need to use an **AL-PCI** cable for this process.



## USB to RS-232 Cable

If your computer does not have a serial COM port (DB-9 male) available, you can plug your AL-PCI2 cable into a special USB to RS-232 cable. Order part PCI-USB for the USB to RS-232 cable only, or ALPCI2-U for both the USB to RS-232 cable and an AL-PCI2 cable).



# Lock Design Overview

## Why Use Software inside a Lock?

With ordinary door locks, the need to make physical copies of metal keys and distributing them can be a huge organizational and financial task -- and what will you do if someone causes a security breach by losing their key?

The answer lies in the advantage of *software*. Software (also called "firmware") is not "hard" or "fixed" like hardware--software is flexible and changeable to your needs. Software can be programmed (and re-programmed again and again) to suit your changing requirements. Rather than copy and distribute metal keys, distribute *User Codes* -- and delete them from the *Lock Program* software when required. (A *User Code* is the software equivalent of a metal key--it is a series of numbers the User enters into the keypad to unlock the lock).

## Preparing to Program your Lock

The DL3000 lock keypad contains 12 buttons, numbers 1 through 9 plus zero, a star button () and a special "AL" button (). You can either use these 12 buttons to program your lock--or--you can program your lock using a computer program called *DL-Windows*. *DL-Windows* is not needed--but it makes programming faster and easier. This guide will show you how to program your lock manually (using only the keypad), without *DL-Windows*. (For more information about *DL-Windows*, see User Guide OI237).



Programming your lock begins after you unpack it from the box -- there is a specific procedure outlined on page 6 ("Quick Start") in which you "wake up" the lock to prepare it for use. To begin programming the lock, you must first enter something called "Program Mode".

## What is Program Mode?

The software inside the lock has two "modes": "Normal Mode" and "Program Mode". When you want to make changes to the lock program (add User Codes for example), enter "Program Mode". When you finish programming and wish to put the lock into use, exit "Program Mode" to enter "Normal Mode".

You enter Program Mode using the keypad--by pressing the *Master Code* of the lock that was set at the factory. The Master Code is basically a secret passcode that allows you to enter Program Mode. But since all locks are identical and leave the factory with the same Master Code, the factory Master Code is therefore not very secret--and *should* be changed to your own personal Master Code. This is to ensure that only YOU can enter Program Mode and make changes to the lock programming.

Once the new Master Code is set, then you can continue with the *Quick Start* procedure and set the weekday, date and time. After this, you can start entering User Codes for people to use. All changes to the lock are organized by their "Function Number". Want to change the date? Use Function Number 38. Want to add a User Code? Use Function Number 2. There are 99 Functions in total, some that you will use often, and others that you may never need.

Notice that when you program your lock, programming tends to follow a consistent 5-step pattern: (1) Enter Program Mode (2) Press  followed by the Function Number (3) Press  and enter data (4) Press  to end (5) Exit Program Mode.

Turn to page 7 and learn about the special terminology used with your lock. The Quick Start procedure (on page 6) will help you get up and running quickly.

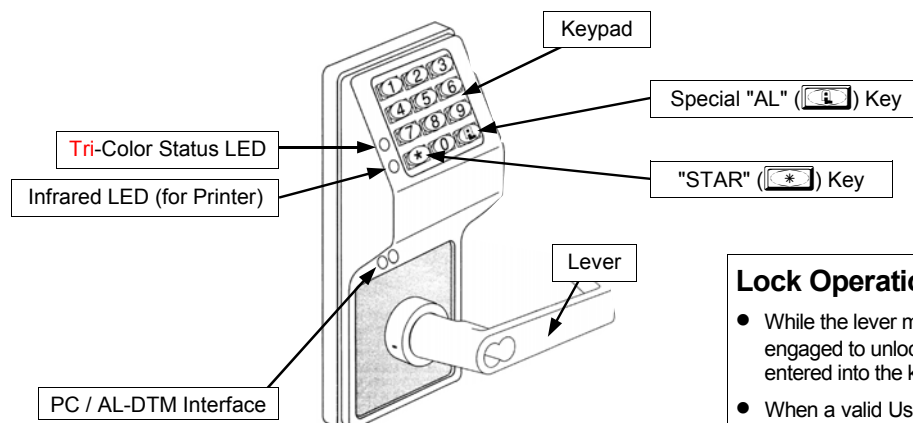

### Lock Operation

- While the lever may be rotated at any time, the latch will not be engaged to unlock the lock unless a valid User Code has been entered into the keypad.
- When a valid User Code is entered, the lock will unlock immediately and remain unlocked for 5 seconds (this 5 second "Pass Time" can be changed--see page 20, functions 51-53).

# Quick Start

## First Time Start Up

**IMPORTANT:** Failure to follow this exact procedure can result in erratic lock behavior.

The DL3000 lock uses five (5) AA-size 1.5 volt alkaline batteries. Remove the back cover, install batteries into the battery pack. Connect the battery pack plugs and the lock will beep 3 times. To load the default program press any key within 5 seconds, the lock will beep slowly while the default values are loaded and beep rapidly upon completion.

## Enter Program Mode and Change Factory Master Code

1. Press the default Master Code: .
2. Wait for the green light and press until multiple beeps are heard. You are now in Program Mode.  
(Note: The lock will beep every 6 seconds as a reminder that you are in Program Mode).
3. Enter a new personal 6-digit Master Code number by pressing the following keys:

[new Master Code] [new Master Code] (the second set of digits must be exactly the same).

(For example, if you want your new Master Code to be "664433". Press:

.

Now that the Master Code has been changed, there is no need to change it again (unless you want to). Since you are still in Program Mode, you can now proceed directly below and program various functions. **Note:** Programming any Function, such as setting the time, follows a consistent 5-step pattern: (1) Enter Program Mode (2) Press [Function #]

- (3) Press and enter data (4) Press to end (5) Exit Program Mode (if desired).

## Set the Weekday

1. Enter Program Mode (if not in already).
2. Press [number of weekday] . (Use 1 = Sunday, 7 = Saturday).  
(For example - Friday - press .

## Set the Date

1. Enter Program Mode (if not in already).
  2. Press [MMDDYY] .
- (For example - May 10, 2002 - press .

## Set the Time

1. Enter Program Mode (if not in already. If you just finished the above procedure, you are still in Program Mode).
2. Press [HHMM] . (Use 24-hour military (HHMM) format, where PM adds 12 hours).  
(For example - 2:30pm - press .

## Enter User Codes

1. Enter Program Mode (if not in already).
  2. Press [User Number] [User Code] .
- (For example, John Smith is designated as User 21. You want him to use the User Code of "232323" to unlock the lock. Program the lock by pressing: .
3. Repeat step 2 for each new User.

## Exit Program Mode

Hold Down any key for 3 seconds. Program Mode exit is confirmed by several beeps. You are now in "normal" operation.

## Re-enter Program Mode

If you wish to re-enter Program Mode, key-in your new 6-digit Master Code, and press .

You are now ready to mount and install your DL3000 series lock and give out your User Codes. Before installation, it is suggested you test and verify that all User Codes entered are active. Use the IR1 infrared printer (available separately) to print your own audit logs and User Codes list.

# Terminology Used in this Manual

## The Lock Program

A Lock Program is stored within the lock's circuitry and contains the instructions that the lock uses to perform its various functions. You can use the keypad to change the Lock Program, and you can also use DL-Windows (defined below) to create a Lock Program on your computer, and then transfer and store the Lock Program within the lock circuitry.

The **Lock Program** consists of 4 areas: **User Codes**, **Functions**, **Time Zones**, and **Schedules**, all defined below:

## User Codes

Also called "User Access Codes", "Passcode numbers" or "PIN Number Codes", a *User Code* is a 3 to 6 digit number the User enters into the keypad (using the keypad buttons) to unlock the lock. The DL3000 can store hundreds of different User Codes in its Lock Program, and the Lock Program is stored in the lock circuitry awaiting the Users to key in their individual User Codes. Each User Code is associated with a *User Number*, defined below.

## The User

A User is defined as a person who is authorized to operate or perform programming changes to the Lock Program. The DL3000 lock can hold hundreds of "Users" (in the form of *User Codes*) in its Lock Program, and each User possesses a pre-defined level of authority--a **Programming Level**--as to their ability to use or make changes to the Lock Program. Some Users may be able to unlock the lock only; others may also be able to make changes to the Lock Program.

## User Numbers

(*User Number = Location Number = User Location = Slot*)

User Numbers are used and are significant within each individual lock only. The DL3000 Series locks can hold up to 300 User Numbers in its Lock Program, which can be thought of as simply a numbered list from 1 through 300 (with number 1 at the top). Each User Number can be programmed with a User Code. In addition, each User Number possesses a pre-defined level of authority--a **Programming Level**--as to the User's ability make changes to the Lock Program. *Where* a User is located in this list--their *User Location*--is a commonly used description of their User Number. Because of their similarities, the terms *User Number*, *User Location* and *Location Number* can be used interchangeably. In some DL-Windows screens, the word "Slot" is also used. They all mean the same thing.

Since User Numbers are fixed, knowing the location of a User Number will specify its associated Programming Level, and will in turn indicate a User's programming abilities (if any). For example, User Number 1 is always the Master, who can perform all programming tasks. Lower down the list, User Number 258 is a Basic User and although this User is assigned a User Code to unlock the lock, because they are a "Basic User" they are unable to perform any programming changes.

## Programming Functions

Your lock is designed to support many different features that can be programmed to suit each installation. Using the keypad (or DL-Windows software), authorized Users can activate these features and make other changes to the Lock Program. Each of these features is called a Programming Function. In addition, each Function possesses its own pre-defined **Program-**

**ming Level** to access that Function. Each User must possess a **Programming Level** EQUAL to the **Programming Level** assigned to the Function in order to access that Function. When programming via the keypad, see page 13 for a list of all Functions 1 through 99. For example, you can enable Daylight Saving Time via Function number 41. Each Programming Function is described on pages 14-26.

## Programming Levels

The Programming Level defines which Programming Functions a User is allowed to perform. Each User Number is associated with a defined level of ability--a **Programming Level**--as to which Functions the assigned User can access. The highest level--Master--allows access to ALL Functions.

In addition, each Function (see pages 14-26) has its own fixed **Programming Level**.

☞ *A User must possess a Programming Level equal to the Programming Level of the Function in order to access that Function.*

Programming Levels can have a value of "1", "2", "3", "4" or "M". **Note:** Having a Programming Level of "3" does not allow access to Functions with Programming Levels of 1, 2 or 4.

The following defaults apply when adding User Codes via Programming Function 2:

**Master:** The highest level User, and always associated with User Number 1 and its Master Code only. Master is always enabled and can program ALL Functions. (Abbreviated as the *Programming Level = "M"*).

**Manager:** Always associated with User Numbers 2-6. Can program all Functions except Functions relating to lock configuration. (Abbreviated as *Programming Level = "1", "2" or "3"*).

**Supervisor:** Always associated with User Numbers 7-11. Can only program Functions relating to certain day to day operations. (Abbreviated as *Programming Level = "1" or "2"*).

**Basic Users:** Always associated with User Numbers 12 through 298. When adding User Codes for Basic Users via Programming Function 2, Programming Levels are not assigned by default. **Note:** Programming Levels for Users 2-255 can be assigned via Function 8. User Numbers 256-300 do not allow programming ability. For Users 299 and 300, see below for entries.

See chart on page 9 for a summary.

## Groups

It is convenient for large numbers of similar Users to be grouped together. By placing Users into Groups (assigning them to a specific range of User Numbers), large numbers of Users can be controlled all at once rather than individually--saving time and effort. Groups are controlled via schedules, and a typical example involves enabling or disabling a Group at a certain time. The DL3000 lock has factory-programmed *Default Group Associations* that are specified in the table on page 9. For example, if you wish to add a User to Group 1, assign this User to a User Number between 51 and 100. These *Default Group Associations* can be changed if needed to allow Groups larger than the default quantity of 50 (by using keypad Function 35). (See page 25 for some Group function examples).

# Terminology Used in this Manual (cont'd)

## TimeZones

Events (recorded lock activities) can be programmed to occur at specific times. It is these times (for example, "every Tuesday at 5PM") that are referred to as *TimeZones*. TimeZones can be created manually through the keypad. In DL-Windows, you can create TimeZones and link events to them.

## Schedules

Program your lock to maintain a schedule in which certain events occur automatically. For example, you can program the lock to allow Groups 1 Users access ONLY during specific business hours. With another example, you can program the lock to UNLOCK at 9AM, LOCK at noon for lunch, UNLOCK at 1PM, and LOCK again at 5PM--every weekday. As you can see, many different combinations of Schedules can be created to suit your installation. First you create *TimeZones* (see above), then create events and link them to your TimeZones.

## Users 299 & 300

User Codes added to locations 299 and 300 have special abilities, as follows:

### User 299: AL-DTM Code

This is the only User Code that will initiate data transfer with the AL-DTM--and without allowing the lock to unlock (the User Code for User Number 299 does NOT allow access). An AL-PCI cable and an AL-DTM (pre-programmed by a computer with DL-Windows) are required.

### User 300: One-Time Only Service Code

This is a one-time-only service User Code designed to be used for access by temporary workers. When enabled, entering User Code 300 into the keypad will allow the DL3000 lock to unlock only once (re-entering User Code 300 will not operate). User Number 300 is enabled by Function 9. **(Note:** Function 9 can only be enabled by Users with a Program Authority Level of 2).

User Code 300 can also be used for guard tour duties.

## DL-Windows

DL-Windows is a computer program that allows you to program your ALARM LOCK Security Lock. You do not need DL-Windows to program your lock, but it makes programming much faster and easier. With DL-Windows, you can quickly create Lock Programs, add multiple Users, retrieve event logs, and create Schedules. The benefit of DL-Windows is that it allows you to set up all lock programming in advance (on your computer), and then later transfer the information into the installed locks at your convenience.

# Conventions Used in this Manual

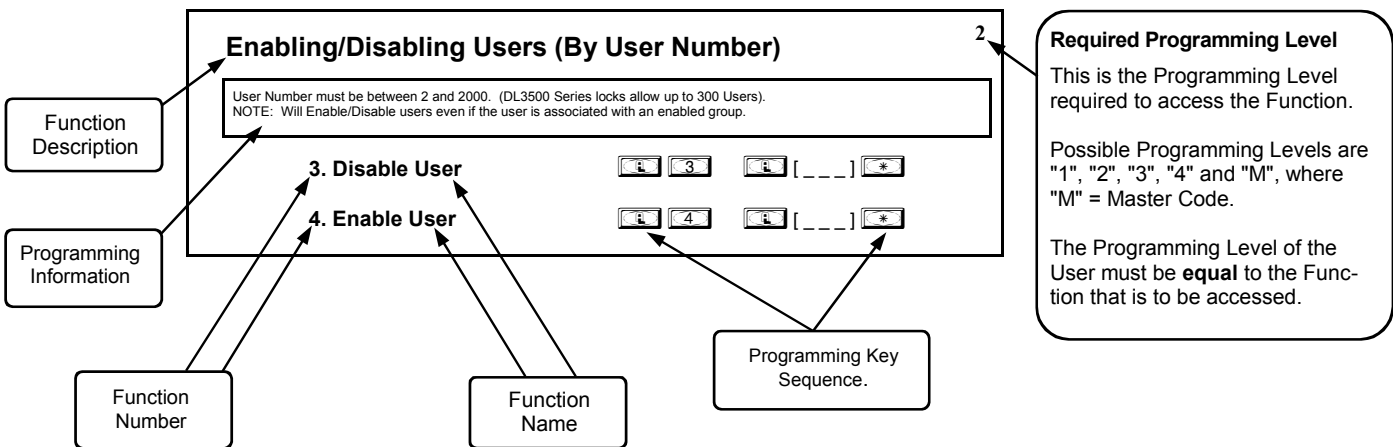

## General Program Mode Information

If a wrong key is pressed during code entry, hold any key continuously until the error sound is heard (7 short beeps), this will clear the entry. Re-enter the key sequence again.

All program sequences are followed by the [\*] key; 2 short beeps indicate a successful program sequence.



# Programming Levels

The Programming Level defines which Programming Functions a User is allowed to perform. Each User Number is associated with a defined level of ability--a **Programming Level**--as to which Functions the assigned User can access. The highest level--Master--allows access to ALL Functions.

In addition, each Function (see pages 14-26) has its own fixed **Programming Level**.

 A User must possess a Programming Level **equal** to the Programming Level of the Function in order to access that Function.

Programming Levels can have a value of "1", "2", "3", "4" or "M". **Note:** Having a Programming Level of "3" does not allow access to Functions with Programming Levels of 1, 2 or 4.

The following defaults apply when adding User Codes via Programming Function 2:

**Master:** The highest level User, and always associated with User Number 1 and its Master Code only. Master is always enabled and can program ALL Functions.

(Abbreviated as the *Programming Level* = "M").

**Manager:** Always associated with User Numbers 2-6. Can program all Functions except Functions relating to lock configuration. (Abbreviated as *Programming Level* = "1", "2" or "3").

**Supervisor:** Always associated with User Numbers 7-11. Can only program Functions relating to certain day to day operations. (Abbreviated as *Programming Level* = "1" or "2").

**Basic Users:** Always associated with User Numbers 12 through 298. When adding User Codes for Basic Users via Programming Function 2, Programming Levels are not assigned by default. **Note:** Programming Levels for Users 2-255 can be assigned via Function 8. User Numbers 256-300 do not allow programming ability.

## Users programmed with Function 2 will default to a Group Association and a Programming Level Ability as follows:

USER TYPE	USER NUMBER	DEFAULT GROUP ASSOCIATION	DEFAULT PROGRAMMING LEVEL
Master Code	1	none	M, 4, 3, 2, 1
Manager Codes	2 - 6	none	3, 2, 1
Supervisor	7 - 11	none	2, 1
Basic User Codes	12 - 50	none	none
Basic User Codes Group 1	51 - 100	1	none
Basic User Codes Group 2	101 - 150	2	none
Basic User Codes Group 3	151 - 200	3	none
Basic User Codes Group 4	201 - 250	4	none
Basic User Codes	251 - 298	none	none
Initiate DTM (Non-Pass Code)	299	none	none
Service Code	300	none	none

**NOTE:**

User Numbers 256-300 do not allow programming ability.

User 299 is a Non-Pass Code. This is the only code that will initiate data transfer with the AL-DTM.

# Wiring, Power Up & Battery Replacement

## WIRING

See the Installation Manual for more information.

### Batteries:

Use only 1.5 volt Duracell Alkaline size-AA batteries. With average use, batteries last about 5 years.

### Terminals (Standard Models Only)

**Red & Black Wires (Operation without Batteries)** - Optional 7.5 VDC Voltage for operation without batteries.

**White & White Wires (Remote Input)** - Wire a Normally Open Contact to Terminals 3 & 4. Momentarily close to allow person to pass through door. **NOTE:** Remote Input is enabled from the factory.

**Yellow, Green & Blue (Normally Open Relay)** - See Function 67 for programming options for the Relay.

**PC Interface** - Connect to Serial Port on Computer using A-PCI interface cable.

### Wire Leads for DL3000WP Models

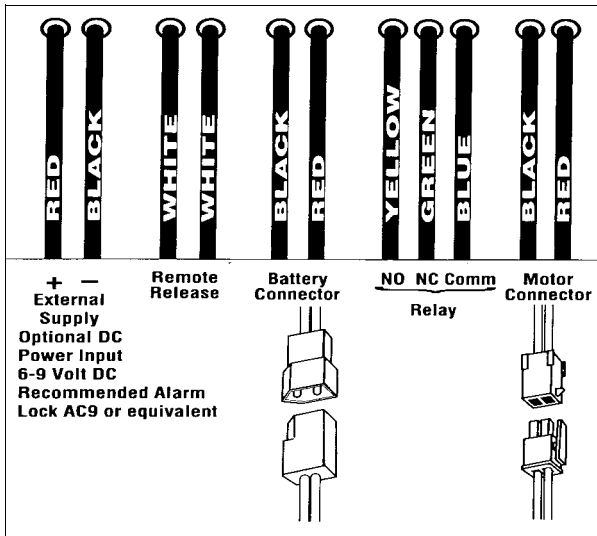

**Note:** On all WP (waterproof) models, be sure to use provided dielectric grease on the battery connector to ensure a waterproof connection.

## POWER DOWN

### --RETAIN LOCK PROGRAMMING

- When applying power to the lock for the first time, stop here and follow the procedure outlined in "QUICK START" on page 6.
- When power is re-applied to a lock that was already operational and you wish to retain the lock programming (such as when transferring the lock from one door to another door), proceed as follows:
  1. Unplug battery pack.
  2. Press any key to ensure the lock's capacitor is fully discharged.
  3. Re-connect battery pack (lock will give 3 short beeps).
  4. **Do not press any keys for 10 seconds.**
  5. After the 10 second period the LED will flash red 6

times and 6 beeps will sound.

**The lock is now ready for use.** Program is loaded from non-volatile (fixed) memory. **Note:** Audit Trail and Clock Settings are lost. Re-set the clock using functions 38, 39 and 40.

## ERASE ALL PROGRAMMING

- The "out of box" factory default will be loaded.

1. Unplug battery pack.
2. Press any key to ensure lock's capacitor is fully discharged.
3. Re-connect battery pack (lock will give 3 short beeps).
4. **Press any key within 5 sec after hearing the 3 beeps.**
5. A series of beeps will be heard.

All settings and programming have been erased and the lock is now ready for use. **Note:** All lock programming can also be erased (without need to disconnect the batteries) by entering Function 99.

## BATTERY REPLACEMENT

- When applying power to the lock for the first time, stop here and follow the procedure outlined in "QUICK START" on page 6.

You will know the batteries are weak when a valid code is entered and the following occurs: the light amber LED lights and the sounder sounds for 4 seconds. The DL3000 lock uses five (5) AA-size 1.5 volt alkaline batteries. Always replace weak batteries as soon as possible.

**CAUTION: Do not press any keys while batteries are disconnected or you may erase the real-time clock settings.** Pressing any key will remove the voltage that is required to keep the system clock and Audit Trail in memory.

1. At the back of the lock, remove the screw at the bottom of the lock housing and remove the cover.
2. Pull out the battery pack and quickly replace all 5 batteries - within 2 minutes.
3. If you **do not** hear the 3 beeps when power is re-applied, all programming and settings have been retained, and the lock is ready for use. Go to step 5.
4. If you **do** hear 3 beeps when power is re-applied, **do not press any keys for 15 seconds.** After the 15 second period, the LED will flash red 6 times and 6 beeps will sound. Reset the clock using functions 38, 39 and 40.
5. Replace the cover and tighten the screw.

# LED and Sounder Indicators

The DL Series locks provide visual and audible keypad feedback. With a fully charged battery, the LED and sounder feedback is as follows:

<b>ACTIVITY</b>	<b>LED</b>	<b>SOUNDER</b>	<b>COMMENTS</b>
Keypress	1 RED Flash	1 Beep	Normal Operation
Access Granted or Remote Input	2 GREEN Flashes	2 Beeps	For Remote Input, wire a normally open contact to these two white wires. Momentarily close to unlock. See page 10 for more information.
Valid Code	1 Momentary GREEN Flash		
Invalid Code	6 RED Flashes	6 Beeps	Re-enter User Code
Successful Program Entry	1+2 GREEN Flashes	1+2 Beeps	When in Program Mode
Unsuccessful Program Entry	7 RED Flashes	7 Beeps	When in Program Mode
Enter Program Mode	2 YELLOW & 1 GREEN LED Flash		
Exit Program Mode	1 RED, 2 GREEN, 1 RED Flashes	2 Groups of 5 Beeps	
Valid but Disabled Code	1 RED, 1 GREEN, 4 RED Flashes	1 long, 5 short Beeps	Code exists in memory, but disabled
Low Battery upon User Code Entry or upon closing of Remote Release switch	YELLOW Flash during key presses	Steady 4-Second Tone	LED and sounder indications occur only when a valid code is entered. See page 10 before changing batteries
User Code Entered	YELLOW Flash	Sequence of 7 Beeps Repeated 4 Times	Non-fatal memory or clock error has been detected. Under this condition, unexpected operation is possible. Remove power and restart. Do not mistake the low battery indication as a memory or clock error
Button Press		Continuous Series of Beeps	System Fault. Ensure batteries are fresh

# Product Communication Examples

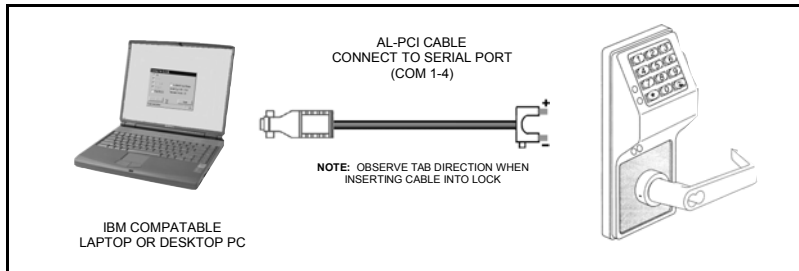
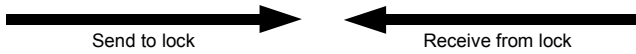

If your computer does not have a serial COM port (DB-9 male) available, you can plug your AL-PCI2 cable into a special USB to RS-232 cable. Order part PCI-USB for the USB to RS-232 cable only, or ALPCI2-U for both the USB to RS-232 cable and an AL-PCI2 cable).



**Scenario 1** Create the program in DL-Windows on your computer, then transfer the program from the computer directly to the lock via an AL-PCI cable. You must always enter the User 298 User Code to send or receive data Using DL-Windows.

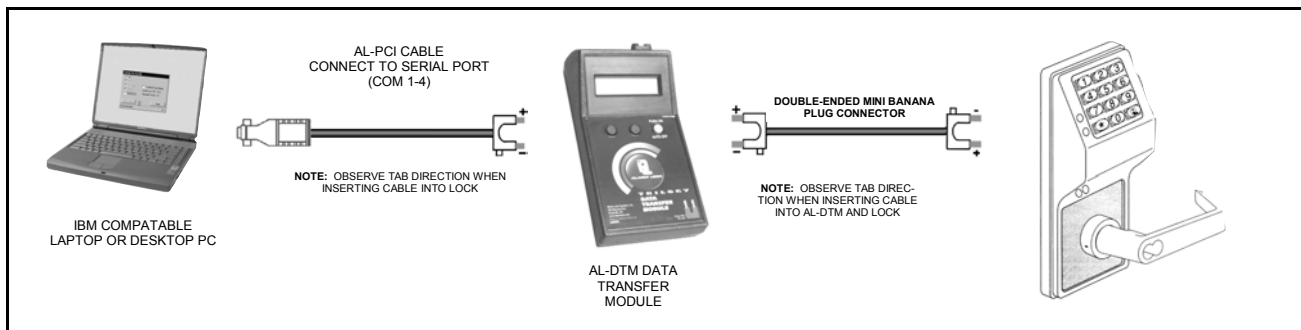

**Scenario 2** Create the program in DL-Windows and transfer the program from your computer to an AL-DTM (via an AL-PCI cable)... then transfer the program from the AL-DTM to the lock(s) (via a double-ended mini banana plug). The hand-held AL-DTM is useful because you do not have to transport (or find electricity for) your computer. Data can also flow in reverse, from the lock, through the AL-DTM, back to the computer for examination.

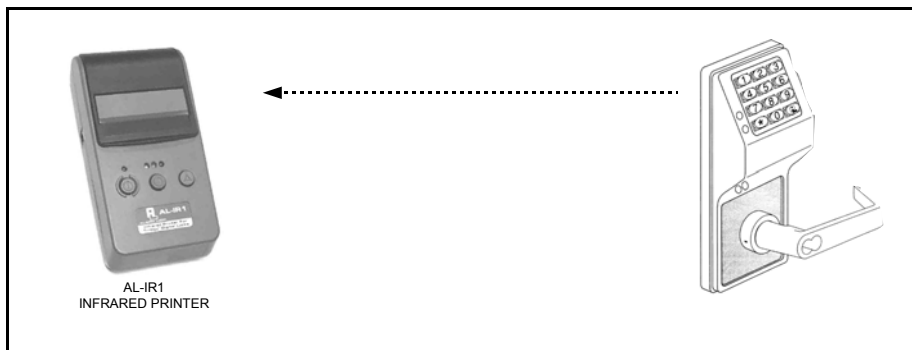

**Scenario 3** Use the AL-IR1 Infrared printer to print your lock's audit trail (event log), User Code list, clock settings and software version. No cable required.

**NOTE:**

The AL-PCI cable is designed to be used on a 9 pin serial COM port. If your computer has a 25 pin COM port, a 25 pin to 9 pin adapter must be used.  
**Warning:** Polarity MUST be observed when connecting cables to the lock. The tab (-) must plug into the negative (black) hole.

# Programming Functions--Overview

FUNCTION NUMBER	DESCRIPTION	PAGE NUMBER
Function 1	New Master Code	14
Function 2	Add/Delete/Change User Codes 2-300	14
Function 3	Disabling Users (By User Number)	14
Function 4	Enabling Users (By User Number)	14
Function 5	User Enable with Timeout	15
Function 6	Enable Total User Lockout Mode	15
Function 7	Disable Total User Lockout Mode	15
Function 8	Change User Programming Level Ability	15
Function 9	Enable User 300 (Service Code)	15
Function 10	Erase All Users Except the Master Code (User 1)	15
Function 11	Reserved	15
Function 12	Clear All Schedules and Timeout Functions	16
Function 13	Clear All Timeout Functions	16
Function 14 - 17	Group 1-4 Disable	16
Function 18	Disable All Groups	16
Function 19 - 22	Group 1-4 Enable	16
Function 23	Enable All Groups	16
Function 24	Reserved	16
Function 25 - 28	Timed Disable Groups 1-4	17
Function 29	Timed Disable All Groups	17
Function 30 - 33	Timed Enable Groups 1-4	17
Function 34	Timed Enable All Groups	17
Function 35	Group Add/Delete Association	17
Function 36 - 37	Reserved	17
Function 38	Set Date	18
Function 39	Set Time	18
Function 40	Set Weekday	18
Function 41	Daylight Saving Time Start Date	18
Function 42	Daylight Saving Time End Date	18
Function 43	Speed Up Clock	19
Function 44	Slow Down Clock	19
Function 45	Enable Passage Mode	19
Function 46	Disable Passage Mode	19
Function 47	Timed Passage Mode	19
Function 48	Enable Permanent Passage Mode	20
Function 49	Disable Permanent Passage Mode	20
Function 50	Return Lock to Normal Passage Mode Schedule	20
Function 51	Set Pass Time 3 to 5 Seconds	20

FUNCTION NUMBER	DESCRIPTION	PAGE NUMBER
Function 52	Set Pass Time to 10 Seconds	20
Function 53	Set Pass Time to 15 Seconds	20
Function 54	Reserved	20
Function 55	Print Audit Trail	21
Function 56	Print User Code List	21
Function 57	Print Clock Settings and Software Version	21
Function 58	Upload/Download PC Data	21
Function 59	Reserved	22
Function 60	Number of Attempts Before Lockout	22
Function 61	Set the Attempts Lockout Time	22
Function 62 - 63	Reserved	22
Function 64	Disable Remote Input	22
Function 65	Enable Remote Input	22
Function 66	Ambush Code	22
Function 67	Add Relay Features	23
Function 68	Delete All Relay Functions and System Options added by Function 67	23
Function 69	Enable Enter Key	23
Function 70	Disable Enter Key	23
Function 71	Reserved	23
Function 72	Schedule Enable Passage Mode (Unlock)	24
Function 73	Schedule Disable Passage Mode (Lock)	24
Function 74 - 77	Schedule Enable Groups 1-4	24
Function 78	Schedule Enable All Groups	24
Function 79 - 82	Schedule Disable Groups 1-4	24
Function 83	Schedule Disable All Groups	24
Function 84 - 87	Quick Schedules - Enable Group	25
Function 88	Passage Mode (Open Time Window)	25
Function 89	Passage Mode (Close Time Window)	25
Function 90	Relay Activation (Open Time Window)	26
Function 91	Relay Activation (Close Time Window)	26
Function 92	Enable Group 4 (Open Time Window)	26
Function 93	Enable Group 4 (Close Time Window)	26
Function 94 - 98	Reserved	26
Function 99	Clear All Lock Programming	26

# Programming Functions

## USERS

### 1. New Master Code (User Number 1)



[ \_ \_ \_ \_ \_ ]  
(New Master Code)

[ \_ \_ \_ \_ \_ ] [\*]  
(Confirm New Master Code)

- Master Code must be 6 digits-only.
- **Factory Default** = [1][2][3][4][5][6]
- **NOTE:** Following a power up, it is highly recommended that Function 1 (New Master Code), be accessed and the factory default Master Code changed before programming any other functions.
- See "Lock Design Overview" on page 5 and "Quick Start" on page 6 for more information about the Master Code.

M

### 2. Add/Delete/Change User Codes 2-300



[ \_ \_ \_ ] \*  
(User Number)

[ \_ \_ \_ \_ \_ ] [\*]  
(User Code)

User Number must be between 2 and 300.

- To delete a code, leave the User Code blank
- User Code must be 3-6 digits
- Each User Code can be thought of as a "User" or a person. As long as each person possesses their own unique User Code, you can control access to the lock by adding or deleting User Codes. See "Terminology Used in this Manual" on page 7 for more information.

3

#### User Code Conflicts

Care should be taken not to program a new User Code which matches the first digits of any other User Code--by default, only the code with the least number of digits would be recognized.

**For example:** If User Codes 123 and 123456 are both entered in the lock, only code 123 would be recognized.

If you wish to program User Codes that match the first digits of other codes, see program Function 69.

**NOTE:** An error will sound if you try to program a new User Code that matches the first digits of the Master User Code (User Number 1).

## Enabling/Disabling Users (By User Number)

- User Number must be between 2 and 300.

**NOTE:** Will Enable/Disable Users even if the User is associated with an enabled Group. Use Feature 3 to disable a specific User Number and their associated User Code. If the disabled User Code is entered, the lock will flash 1 Green and 4 Red Flashes (with 1 long and 5 short beeps) indicating that the User Code exists in memory, but is disabled. Function 4 will "undo" Function 3.

2

### 3. Disable User



[ \_ \_ \_ ] [\*]  
(User Number)

### 4. Enable User



[ \_ \_ \_ ] [\*]  
(User Number)

# Programming Functions (cont'd)

## USERS (Continued)

### 5. User Enable with Timeout

(Enter Timeout, XXX Hours)

(This Function enabled through keypad only)

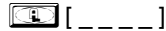

(User Number)



(XXX Hours)

- With Function 5, User Numbers must be between 2-300, hours must be between 1-999.
- Function 5 can temporarily override a disabled User (disabled using Function 3 above).
- Since this is a temporary feature, Function 5 can only be enabled using the keypad.
- **Example:** Brian, User Number 157, rarely works at the office, but when he does, enable him for his 8 hour work day ("008") by entering Program Mode and pressing:
- **NOTE:** Up to 4 Timeout Functions may be pending at any one time. An error beep will sound when attempting to program more than 4 Timeout Functions.

2

### User Lockout Mode

Prevents all User Codes (Except User 1 Master Code) from operating the lock. **Note:** Other programming functions or schedules will NOT re-enable Users. Users must be re-enabled with Function 7. **Note:** Does not change the User enable/disable status. **Note:** If the lock is currently in Passage Mode ("door unlocked") and Function 6 is programmed, the lock will remain in Passage Mode.

M

### 6. Enable Total User Lockout Mode

(This Function enabled through keypad only)



### 7. Disable Total User Lockout Mode

(This Function enabled through keypad only)



### 8. Change User Programming Level Ability



(User Number)



(Programming Levels)

User Number must be between 2 and 255. The ability to program one or more **Programming Levels** may be selected.

3

**Example 1:** Allow "Basic" User 67 to program levels 1, 2 and 4. Enter:



**NOTE:** User 67 does not have access to Programming Functions with a Program Level Ability of 3.

**Example 2:** Prevent User 67 from programming any programming levels. Enter:



**NOTE:** Having a Program Level Ability of 4 does not allow access to functions requiring a Program Level Ability of 3, 2 or 1. If multiple levels are required, program for each level that is required. User Numbers 256-300 do not allow programming ability.

### 9. Enable User 300 (Service Code)

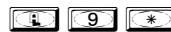

Service Code is a "One-Time-Only" code. Once it is used, it is disabled until enabled again.

2

### 10. Erase All Users Except the Master Code (User 1)

(This Function enabled through keypad only)

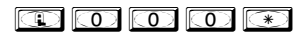

Erases all User Codes except the Master Code (User 1).

M

### 11. Reserved

# Programming Functions (cont'd)

## CLEAR FUNCTIONS

### 12. Clear All Schedules and Timeout Functions



3

Function 12 clears all programmed *Schedules* and all *Timeout Functions*. (To clear All Timeout Functions only, see Function 13 below). Function 12 will clear all of the following: All Schedule Functions 72 through 93, Timeout Functions 5, 25 through 34 and Function 47. **Note:** Function 12 also resets Passage Mode and any disabled Groups. After using Function 12, your Scheduled/Timeout features must be manually re-programmed.

**NOTE:** Up to 4 Timeout Functions may be pending at any one time. An error beep will sound when attempting to program more than 4 Timeout Functions. This Function only disables the timeout; the event associated with the timeout will remain

### 13. Clear All Timeout Functions

(This Function enabled through keypad only)



3

Function 13 clears all *Timeout Functions*. (To clear All Schedules and Timeout Functions, see Function 12 above). Function 13 will clear all of the following: All Timeout Functions 5, 25-34 and Function 47. After using Function 12, your Scheduled/Timeout features must be manually re-programmed.

**NOTE:** Up to 4 Timeout Functions may be pending at any one time. An error beep will sound when attempting to program more than 4 Timeout Functions. This Function only disables the timeout; the event associated with the timeout will remain

**Important:** It is the responsibility of the lock programmer to verify the proper lock/unlock conditions and Group conditions after programming the lock with Function 12 and 13.

## GROUPS

### Group Enable/Disable

Enter the functions below to Enable/Disable Groups. Functions 14 - 23 will each override existing scheduled events. Therefore, Functions 14 - 23 are temporary, take effect immediately, and are always overridden by future scheduled events that already exist within the lock programming.

2

14. Disable Group 1



15. Disable Group 2



16. Disable Group 3



17. Disable Group 4



18. Disable All Groups



19. Enable Group 1



20. Enable Group 2



21. Enable Group 3



22. Enable Group 4



23. Enable All Groups



### PRIORITY ORDER

1. Disabled Users
2. Enabled Groups
3. Disabled Groups
4. Enabled Users

The "Priority Order" details which Function will take effect before ("have priority over") others. For example, as per the list above, Enabled Users have the lowest priority, and other Functions can affect the status of these Users. Disabling a Group (Functions 14-18) will take priority over the enabled Users in that Group, disabling them. Enabling Groups (Functions 19-23) will take priority over those tasks lower in the list, and finally disabling a User (Function 3) takes priority over all other tasks listed.

24. Reserved



# Programming Functions (cont'd)

## GROUPS

**NOTE:** Clear All Timeout Functions by entering Function 13.

### Group Enable/Disable with Timeout (Enter Timeout, XXX Hours)

(Functions 25-34 are enabled through the keypad only)

- Hours must be between 1-999. Enter the functions below to Enable/Disable Groups for the amount of time entered in hours. 2  
**NOTE:** Only 4 Timeout Functions are allowed at any one time. An error beep will sound when attempting to program more than 4 Timeout Functions. Functions 25 - 34 will each override existing scheduled events. Therefore, Functions 25 - 34 are temporary, take effect immediately, and are always overridden by future scheduled events that already exist within the lock programming.
- Example:** All 15 members of the Accounting Department are members of Group 4, and a schedule programmed in the department's door lock reflects their normal working hours of 9 AM through 5 PM, Monday through Friday. But one day a special event occurs, and all Accounting Department members are requested to stay an extra hour until 6 PM. Therefore, at 5 PM, the manager (wishing to temporarily enable Group 4 users for an extra hour) enters Program Mode and presses: . Likewise, if the manager wished to send his department home early at 3 PM, the manager could enter .

25. Timed Disable Group 1

(XXX Hours)

26. Timed Disable Group 2

(XXX Hours)

27. Timed Disable Group 3

(XXX Hours)

28. Timed Disable Group 4

(XXX Hours)

29. Timed Disable All Groups

(XXX Hours)

30. Timed Enable Group 1

(XXX Hours)

31. Timed Enable Group 2

(XXX Hours)

32. Timed Enable Group 3

(XXX Hours)

33. Timed Enable Group 4

(XXX Hours)

34. Timed Enable All Groups

(XXX Hours)

### 35. Group Add/Delete Association

(User Number) (Groups)

As per the table on page 9, the lock's default programming from the factory associates certain User Numbers with certain Groups. To override these default Group associations, Function 35 manually associates (or disassociates) a selected User with a selected Group. During programming, Groups not selected are then disassociated from the User. Function 35 is helpful when the number of Users you wish to add to a Group outgrows the number of User Numbers defaulted to a Group (50); or if an existing User joins a department and you wish to simply add them to a Group. 3

- User Number must be between 2 and 300; Groups 1-4 (to associate with User) may be selected.

**Add Example:** To associate User 67 with Groups 1, 2 and 4;

Enter:

**Delete Example:** To remove all Group associations for User 67;

Enter:

**NOTE:** If a User is associated with more than one Group, all associated Groups would have to be disabled before the User is disabled.

36 - 37. Reserved



# Programming Functions (cont'd)

## CLOCK ADJUST

### Clock Adjust

Number of seconds to adjust (speed up/slow down) the clock each day must be between 0-55 seconds.

**Note:** Repeated use of these Functions are not "cumulative" (this means, for example, if the clock has *already* been set to speed up 10 seconds per day, and then is found to need an additional 10 seconds, then program 20 seconds using Function 43).

**Example 1:** Clock is losing 13 seconds every day, enter:

This example assumes that the Clock Adjust setting was at the factory default of zero. Function 57 can be used to print the current Clock Adjust setting.

**Example 2:** Clock is gaining 13 seconds every day, enter:

This example assumes that the Clock Adjust setting was at the factory default of zero. Function 57 can be used to print the current Clock Adjust setting.

**Example 3:** To set the clock adjust setting back to the factory default of zero, enter:

or

4

#### Clock Accuracy

The internal oscillator is factory calibrated to an accuracy of  $\pm 5$  minutes/year. Changes in ambient temperature may affect accuracy. If necessary, the accuracy of the internal clock may be adjusted by first updating the correct time via Function 39. After an interval of about 1 month, re-set the correct time via Function 39 and then print an Audit Log via Function 55. Because the Audit Log displays both the "New Clock Time" and the "Old Clock Time", a daily accuracy (in seconds) can be determined by taking the difference in seconds between the "Old" and "New" times divided by the number of days between the two Function 39 entries. **Note:** Because the minimum available adjustment is 1 second per day, the inaccuracy of the clock must exceed about 6 minutes per year before adjustment is necessary.

### 43. Speed Up Clock

(This Function enabled through keypad only)

(seconds)

### 44. Slow Down Clock

(This Function enabled through keypad only)

(seconds)

## PASSAGE MODE

### Passage Mode Enable/Disable - Schedule will Override

- Function 45 allows passage through the door without the need for a User Code. Re-Lock using Function 46.
- Programmed Schedules will override the state of the lock when Functions 45 and 46 are used. If it is required that programmed schedules do not override Passage Mode, enable/disable Passage Mode using Functions 48/49. **Note:** Because of the temporary nature of these features, Functions 45-47 can only be enabled using the keypad.

2

### 45. Enable Passage Mode

(This Function enabled through keypad only)

### 46. Disable Passage Mode

(This Function enabled through keypad only)

### 47. Timed Passage Mode

(This Function enabled through keypad only)

(XXX Hours)

- Hours must be between 1 - 999. Function 47 allows passage through the door without the need for a User Code for the programmed amount of time.
- For example, if you wish your office door lock to be unlocked (unlocked = "Passage Mode") for the next 3 hours, enter Program Mode and press:

2

# Programming Functions (cont'd)

## PERMANENT PASSAGE MODE

### Passage Mode Enable/Disable - Schedule will not Override

- Function 48 allows passage through the door without the need for a User Code. Re-Lock using Function 49.
- Programmed Schedules will not override the state of the lock using functions 48 and 49. If it is required that programmed schedules override Passage Mode, Enable/Disable Passage Mode using Functions 45/46. Use Function 50 to "undo" Functions 48 and/or 49, and therefore return the lock to all pre-existing scheduled functions. **Note:** Functions 48-50 can only be enabled using the keypad. **Warning:** Function 49 will inhibit all scheduled Passage Mode events.

2

#### 48. Enable *Permanent Passage Mode*

*(This Function enabled through keypad only)*



#### 49. Disable *Permanent Passage Mode*

*(This Function enabled through keypad only)*



#### 50. Return Lock to Normal Passage Mode Schedule

*(This Function enabled through keypad only)*

(Locks will lock or unlock depending on the current schedule). Use Function 50 to "undo" Functions 48 and/or 49, and therefore return the lock to all pre-existing scheduled functions.



**NOTE:** See Scheduled functions 72 and 73 for Scheduled Passage Mode.

## PASS TIME

### Pass Time

The Pass Time is the length of time the lock stays unlocked after a valid User Code is entered. When the Pass Time expires, the lock will re-lock automatically. Use the functions below to change the Pass Time to 3-5, 10 or 15 seconds. **The Pass Time is defaulted to 3-5 seconds.**

4

#### 51. Set Pass Time 3 to 5 Sec.



#### 52. Set Pass Time to 10 Sec.



#### 53. Set Pass Time to 15 Sec.



#### 54. Reserved

# Programming Functions (cont'd)

## PRINTER

Hold the printer's tab perpendicular to the Lock's infrared LED as shown in Figure 1 and Figure 2. If the printer has been idle for some time, press the paper feed button to "wake up" the printer.

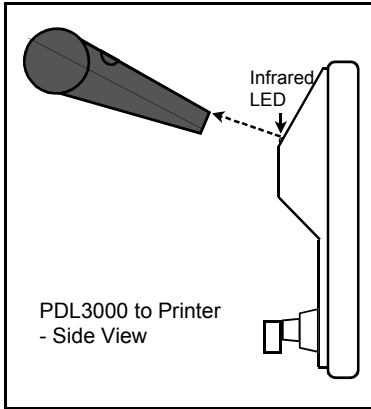

Figure 1

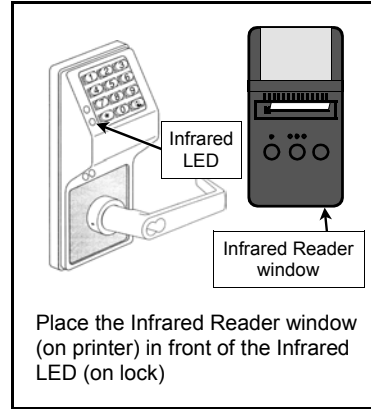

Figure 2

### 55. Print Audit Trail



Hold the printer over the lock's infrared sensor as shown in Figure 1 and Figure 2. 20 events will print at a time; press 1 for more events, or 9 to quit. To abort printing, press any key for 3 Sec (Three short beeps will sound).

1

```
----- AUDIT LOG -----
04/07/06 13:06:35 Tue
13:01:59 001 PROGRAM 56
13:01:29 001 PROGRAM 57
13:00:53 001 ENTRY
13:00:26 013 ENTRY
13:00:03 012 ENTRY
12:56:27 001 PROGRAM 2
12:56:27 001 PROGRAM 40
12:56:04 001 PROGRAM 39
12:55:00 NEW CLK TIME
12:01:39 OLD CLK TIME
12:01:30 001 PROGRAM 38
12:01:30 DATE CHANGED
12:01:07 001 ENTRY
12:00:48 CLK TEST:PASS
12:00:45 RAM TEST:PASS
12:00:45 POWER UP
-----
End of Audit Log
```

### 56. Print User Code List



Hold the printer over the lock's infrared sensor as shown in Figure 1 and Figure 2. To abort printing, press any key for 3 Sec (Three short beeps will sound).

3

```
04/07/06 13:06:35 Tue
USER
ENABLED ?
USER|USER |GROUP|PROG
NUM|CODE| |SETS
1 123456 E .... 46525
12 987 E .....
13 246 E .....
-----
```

### 57. Print Clock Settings and Software Version



Hold the printer over the lock's infrared sensor as shown in Figure 1 and Figure 2.

1

```
ALARM LOCK SYSTEMS, INC
VERSION DL26 org REC
04/07/06 13:11:28 Tue
Clock adjust setting +0
Cycle count hex 00000E
F39 day ct hex 00
```

## DOWNLOADING

### 58. Upload/Download PC Data



For use with DL-WINDOWS software, refer to OI237; an AL-PCI interface cable is needed.

3

# Programming Functions (cont'd)

## AL-DTM

### 59. Reserved

## LOCKOUT

### 60. Number of Attempts Before Lockout

[ \_ ]

(Number of Attempts)

- Number of attempts before lockout must be 1-9 attempts.
- The number of attempts is reduced by half every time the keypad is locked out without a successful code entry (default is 6 attempts).
- The attempt count is reset each time a valid code is entered.

4

### 61. Set the Attempts Lockout Time

[ \_ \_ ]

(Lockout Time)

- Lockout Time must be 1-60 seconds. This functions defines how long the keypad is locked out after a series of unsuccessful attempts (default is 15 seconds).

4

### 62-63. Reserved

## REMOTE INPUT

### Remote Input Disable/Enable

- Wire a Normally Open Contact to Terminals 3 & 4. Momentarily close to allow person to pass through door.
- Enter the functions below to Disable/Enable the Remote Input.

**NOTE:** The Remote Input is enabled as part of the default program.

2

### 64. Disable Remote Input

### 65. Enable Remote Input

## AMBUSH

### 66. Ambush Code

[ \_ \_ ]

(Ambush Code)

- Ambush code must be 2 digits.
- An error will sound if the ambush code matches the 1st two digits of any User Code.

3

# Programming Functions (cont'd)

## RELAY FEATURES

### 67. Add Relay Features

6 7 [ \_ \_ ] \* 4  
 (Event Number)

Use Function 67 to program **one or more** lock events and the Relay will energize when the programmed event(s) listed below occurs. For example, program 6 7 3 \* and when an attempted entry fails (such as a User who enters an incorrect or un-programmed User Code), the Relay will energize for 2 seconds. **Note:** For more information about the *Remote Input*, see page 10 (Wiring, Remote Input) and page 22 (Function 65).

1. <b>Remote Input switch closed and Function 65 Remote Input enabled.</b> Because the Remote Input is enabled by factory default, the Relay will energize when the Remote Input switch is closed.	7. <b>Scheduled Lock Event.</b> Relay energizes for 2 seconds when lock is locked by a Schedule.
2. <b>Remote Input switch closed and Function 64 Remote Input disabled.</b> If the Remote Input is disabled with Function 64, the Relay will energize when the Remote Input Switch is closed.	8. <b>Scheduled Unlock Event.</b> Relay energizes for 2 seconds when lock is unlocked by a schedule
3. <b>Failed attempted entry.</b> Relay energizes for 2 seconds when an attempted User Code entry via the keypad fails.	9. <b>Lock Out.</b> Relay energizes for 2 seconds when a Lock Out occurs (i.e. number of attempts is exceeded, see Function 60).
4. <b>Disabled User or Group.</b> Relay energizes for 2 seconds when a disabled User or disabled Group member enters a User Code.	10. <b>Ambush.</b> Relay energizes for 2 seconds when Ambush is tripped. See Function 66, page 22 and "Ambush Function" below.
5. <b>Follow Access Granted.</b> When a valid User Code is entered into the keypad and the lock unlocks, the Relay energizes for 2 seconds. Compare with Event 31.	11. <b>First Key Press.</b> Relay energizes for 2 seconds at the first key press of any sequence.
6. <b>Group 1 User Code.</b> Relay energizes for 2 seconds when a scheduled Group 1 User Code is entered. See Function 90, page 26.	

#### Ambush Function

1. Connect relay to a device able to properly monitor dry contacts for an *Ambush* condition.
2. Program the Relay for *Ambush Tripped* using Program Function 67(10) above.
3. Set the Ambush Code using Program Function 66.
4. When the Ambush Code is entered followed by a valid User Code, the relay will close for 2 seconds.

**Notes:** The Ambush Code defaults to **99**. An error will sound if you try to program a new User Code starting with the Ambush Code.

### 68. Delete All Relay Features added by Function 67.



Enter 6 8 0 0 0 \* to delete all Relay Features added by Function 67. 4

## ENTER KEY

### Enter Key Enable/Disable (Allows Programming of Codes that Match the 1st digits of other Codes)

- When enabled, the user must press \* after a User Code entry, allowing User Codes to be subsets of other User Codes. For example:

1 2 3 \* is a valid User Code;

1 2 3 4 \* is also a valid User Code

#### 69. Enable \* as Enter Key



#### 70. Disable \* as Enter Key



### 71. Reserved

# Programming Functions (cont'd)

## SCHEDULES

### Scheduled Passage Mode Enable/Disable

Use the functions below to Enable/Disable Schedule Passage Mode.  
 For day enter: 1 for Sunday, 2 for Monday, 3 for Tuesday, 4 for Wednesday, 5 for Thursday, 6 for Friday, 7 for Saturday, 8 for Monday to Friday, 9 for Saturday and Sunday, 0 for all days of week.

3

**72. Schedule Enable Passage Mode (Unlock)**



[\_] (Day)

[\_] [ ] [\*] (Time)

**73. Schedule Disable Passage Mode (Lock)**



[\_] (Day)

[\_] [ ] [\*] (Time)

## SCHEDULES

**NOTE:** Clear All Schedule and Timeout Functions by entering Function 12.

### Scheduled Group Enable/Disable

Use the functions below to Enable/Disable Groups at the time programmed.

3

For day enter: 1 for Sunday, 2 for Monday, 3 for Tuesday, 4 for Wednesday, 5 for Thursday, 6 for Friday, 7 for Saturday, 8 for Monday to Friday, 9 for Saturday and Sunday, 0 for all days of week.

**74. Schedule Enable Group 1**



[\_] (Day)

[\_] [ ] [\*] (Time)

**75. Schedule Enable Group 2**



[\_] (Day)

[\_] [ ] [\*] (Time)

**76. Schedule Enable Group 3**



[\_] (Day)

[\_] [ ] [\*] (Time)

**77. Schedule Enable Group 4**



[\_] (Day)

[\_] [ ] [\*] (Time)

**78. Schedule Enable All Groups**



[\_] (Day)

[\_] [ ] [\*] (Time)

**79. Schedule Disable Group 1**



[\_] (Day)

[\_] [ ] [\*] (Time)

**80. Schedule Disable Group 2**

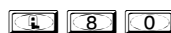

[\_] (Day)

[\_] [ ] [\*] (Time)

**81. Schedule Disable Group 3**

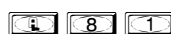

[\_] (Day)

[\_] [ ] [\*] (Time)

**82. Schedule Disable Group 4**

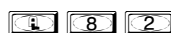

[\_] (Day)

[\_] [ ] [\*] (Time)

**83. Schedule Disable All Groups**

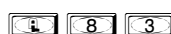

[\_] (Day)

[\_] [ ] [\*] (Time)



# Programming Functions (cont'd)

## QUICK SCHEDULES

### Quick Schedules - Enable Group

For your convenience, your lock comes pre-programmed with Quick Schedules, which, when programmed, enable Groups for popular blocks of time. Group members will be enabled during the blocks of time defined below, but will still need to enter their User Codes into the keypad to unlock the lock.

3

- Group number must be 1-4; enter the number of the Group that is to be enabled for the time specified by the Quick Schedules below.

**Note:** These Quick Schedules can **only** be programmed through the keypad (not through DL-Windows), and existing Quick Schedules **will be over-written** by schedules downloaded from DL-Windows. Therefore, after downloading any DL-Windows schedules, be sure to re-program your Quick Schedules into your Lock Program.

**84. Business Quick Schedule**  
7AM-5PM, Monday - Friday



**85. Day Quick Schedule**  
7AM-5PM, All days



**86. Evening Quick Schedule**  
3PM-1AM, All days



**87. Night Quick Schedule**  
11PM-9AM, All days



## SCHEDULES GROUP 1 ACTIVATED

### Scheduled Passage Mode (Group 1 Activated)

Functions 88 and 89 allow you to set up a window of time where if any **Group 1** User Code is entered within this window, Passage Mode will be activated, allowing anyone to enter. **Note:** This feature can only be programmed using the lock keypad. For additional information, see Group 1 Activated Features on page 27.

3

- For the **day** enter: 1 for Sunday, 2 for Monday, 3 for Tuesday, 4 for Wednesday, 5 for Thursday, 6 for Friday, 7 for Saturday, 8 for Monday to Friday, 9 for Saturday and Sunday, and 0 for all days of week.
- Enter time of day in 24 hour format (for example, for 2:15 PM, enter 14:15).

**88. Passage Mode**  
(Open Time Window)

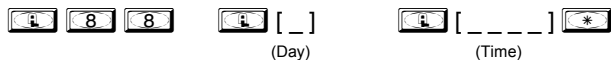

**89. Passage Mode**  
(Close Time Window)

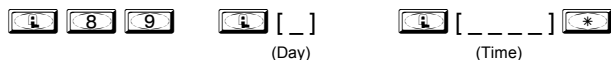







# Programming Functions (cont'd)

## SCHEDULES GROUP 1 ACTIVATED

### Scheduled Relay Activation (Group 1 Activated)

Functions 90 and 91 allow you to set up a window of time where if any **Group 1** User Code is entered within this window, the relay will be activated for 2 seconds. For additional information, see Group 1 Activated Features on page 27.

3

- Also program Relay Function 6 using Function 67 (     .
- For **day** enter: 1 for Sunday, 2 for Monday, 3 for Tuesday, 4 for Wednesday, 5 for Thursday, 6 for Friday, 7 for Saturday, 8 for Monday to Friday, 9 for Saturday and Sunday, and 0 for all days of week.
- Enter time of day in 24 hour format (for example, for 2:15 PM, enter 14:15).

#### 90. Relay Activation (Open Time Window)

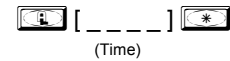
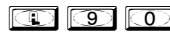

#### 91. Relay Activation (Close Time Window)

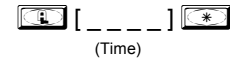

### Scheduled Group 4 Enable (Group 1 Activated)

Functions 92 and 93 allow you to set up a window of time where if any **Group 1** User Code is entered within this window, Group 4 members will be enabled. (Group 4 members will still need to enter their User Codes to enter). For additional information, see Group 1 Activated Features on page 27.

3

- For **day** enter: 1 for Sunday, 2 for Monday, 3 for Tuesday, 4 for Wednesday, 5 for Thursday, 6 for Friday, 7 for Saturday, 8 for Monday to Friday, 9 for Saturday and Sunday, and 0 for all days of week.
- Enter time of day in 24 hour format (for example, for 2:15 PM, enter 14:15).

#### 92. Enable Group 4 (Open Time Window)

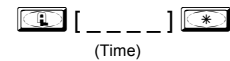

#### 93. Enable Group 4 (Close Time Window)

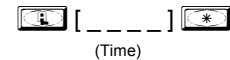

### 94 - 98. Reserved

## CLEAR ALL PROGRAMMING

### 99. Clear All Lock Programming



Clears all programming and returns lock to factory default settings. Audit Trail contents are maintained.

M

# Groups and Scheduled Group 1 Examples

The following examples detail the more advanced features of the DL3000 lock. Although all features and device functions can be programmed using the lock keypad, when programming becomes more complex you may find it easier to use DL-Windows software to program your Alarm Lock security lock. For more information, contact your Alarm Lock security professional.

## Assign a User to Two Groups

Create a User 101 (all Users 101-150 are members of Group 2 by default) and include User 101 in Group 3 (as well as the default Group 2).

1. Enter Program Mode (if not in already).
2. Using Function 2, create User 101 with a User Code of "789":  
Press 2 1 0 1 7 8 9 .
3. Using Function 35, make User 101 a member of Group 2 and 3:  
Press 3 5 1 0 1 2 3 .
4. Exit Program Mode.

**Note:** See step 3 above--although User 101 is by default a member of Group 2, you must include Group 2 when using Function 35 or the Group 2 association will be removed.

The example to add Users to Group 2 and Group 3 has been selected due to the fact that *Group 1 Activated Functions* require that a member of Group 1 enter their User Code to activate the Function, and it may become necessary to assign Users to Groups.

## Group 1 Activated Features: Functions 88/89, 90/91 and 92/93

- **Function 88 and 89** allow for a window of time to be created where if any Group 1 User Code is entered within the programmed window, *Passage Mode* will be activated (the device physically unlocks, allowing passage for all). If a Group 1 User does not enter their User Code during the specified window, Functions 88/89 remain inactive.
- **Function 90 and 91** allow for a window of time to be created where if any Group 1 User Code is entered within the programmed window, an internal *Relay* will be activated for 2 seconds. If a Group 1 User does not enter their User Code during the specified window, Functions 90/91 remain inactive.
- **Function 92 and 93** allow for a window of time to be created where if any Group 1 User Code is entered within the programmed window, the *User Codes in Group 4* will be enabled. If a Group 1 User does not enter their User Code during the specified window, Functions 92/93 remain inactive. Companies typically use this feature to allow Group 1 Managers the ability to enable all Group 4 staff members during a certain window of time.

The following examples illustrate how Functions 88-93 can be programmed into your DL Series lock via the keypad:

**Functions 88/89:** Use Function 88 to set an *Open Time Window* (during which the Group 1 User must enter their User Code), and then use Function 89 to set the time to close the Window. Re-lock the door at night manually (Function 46).





































1. Enter Program Mode (if not in already).
2. Using Function 2, create User 4 with a User Code of "456789":  
Press 2 4 4 5 6 7 8 9 .
3. Because User 4 does not have a default Group association, make User 4 a member of Group 1 using Function 35:  
Press 3 5 4 1 .
4. Use Function 88 and Function 89 (see page 25) to designate *Passage Mode* as being between the hours of 8:30 A.M. and 10 A.M. for all days of the week:  
**Function 88** (Open Window Time) = 8:30 A.M.: Press 8 8 0 0 8 3 0   
**Function 89** (Close Window Time) = 10:00 A.M.: Press 8 9 0 1 0 0 0
5. Exit Program Mode (hold down any key for 3 seconds).

The lock will now be put in *Passage Mode* (device physically unlocked) if User 4 (or any Group 1 member) enters their User Code between 8:30 A.M. and 10 A.M. If a Group 1 User does not enter their User Code during the specified window, Functions 88/89 remain inactive

- The device will have to be manually locked each night by entering the following command using Function 46:  
 4 6
- The device can also be programmed to automatically lock (disable *Passage Mode*) each night at 5 P.M. by using Function 73:  
 7 3 0 1 7 0 0
- Remember to exit Function Mode when programming is complete.









































# Groups and Scheduled Group 1 Examples (cont'd.)

**Functions 90/91:** Use Function 90 and 91 (see page 26) to create a window of time where if any Group 1 User Code is entered within the programmed window, a *Relay* will be activated for 2 seconds.



































1. Enter Program Mode (if not in already).
2. Connect Relay to a device to be activated.
3. Using Function 2, create User 4 with a User Code of "456789":  
Press           .
4. Because User 4 does not have a default Group association, make User 4 a member of Group 1 using Function 35:  
Press      .
5. Use Function 90 to set the time to open the window (8:30 A.M. all days of the week) allowing any Group 1 member to close the Relay for 2 seconds. **Note:** Only 1 Relay closure will occur even if another member of Group 1 enters their User Code. Use Function 91 to set the time to close the window (10 A.M. for all days of the week):  
**Function 90** (Open Window Time) = 8:30 A.M.: Press           
**Function 91** (Close Window Time) = 10:00 A.M.: Press          
6. Exit Program Mode (hold down any key for 3 seconds).

The Relay will close, one time only, when a member of Group 1 enters their User Code between 8:30AM and 10:00AM. If a Group 1 User does not enter their User Code during the specified window, Functions 90/91 remain inactive

**Functions 92/93:** Use Function 92 and 93 (see page 26) to create a window of time where if any Group 1 User Code is entered within the programmed window, *Group 4 Users* will be enabled.

1. Enter Program Mode (if not in already).
2. Using Function 2, create User 4 with a User Code of "456789":  
Press           .
3. Because User 4 does not have a default Group association, make User 4 a member of Group 1 using Function 35:  
Press      .
4. Using Function 17, disable Group 4. (Group 4 will need to be "disabled" before it can be "enabled" later).  
Press    .
5. Use Function 92 to set the time to open the window (8:30 A.M. all days of the week) allowing any Group 1 member to enable Group 4. Use Function 93 to set the time to close the window (10:00 A.M. all days of the week).  
**Function 92** (Open Window Time) = 8:30 A.M.: Press           
**Function 93** (Close Window Time) = 10:00 A.M.: Press          
6. Exit Program Mode (hold down any key for 3 seconds).

The lock will now enable Group 4 User Codes if User 4 (or any Group 1 member) enters their User Code between 8:30 A.M. and 10 A.M. If no Group 1 member arrives to enter their User Code between 8:30 A.M. and 10 A.M., Group 4 User Codes will not be enabled and will remain disabled all day.

- The device will have to be manually locked each night by entering the following command using Function 82:  
   
- The device can also be programmed to automatically disable Group 4 members each night at 5 P.M. by using Function 82:  
         
- Test the device by creating User 222 (with User Code 466466) and adding User 222 to Group 4:  
             
       
- Remember to exit Function Mode when programming is complete.

# Programming Record Sheet

Default Values are shown in parentheses.

Function Number(s)	Function Name	Programming				
40/41	Daylight Savings Time Enable/Disable	Enable [ ] Disable [ ] (Enable)				
43/44	Clock Adjust	+/- <table style="display: inline-table; border-collapse: collapse;"><tr><td style="border: 1px solid black; width: 20px; height: 15px;"></td><td style="border: 1px solid black; width: 20px; height: 15px;"></td></tr><tr><td style="text-align: center; font-size: 8px;">(0)</td><td style="text-align: center; font-size: 8px;">(0)</td></tr></table> 0-55 seconds Seconds			(0)	(0)
(0)	(0)					
51/52/53	Pass Time	3-5 sec [ ] 10 sec [ ] 15 sec [ ] (3-5 sec)				
60	Number of Attempt Before Lockout	<table style="display: inline-table; border-collapse: collapse;"><tr><td style="border: 1px solid black; width: 20px; height: 15px;"></td></tr><tr><td style="text-align: center; font-size: 8px;">(6)</td></tr></table> 1-9 attempts Attempts		(6)		
(6)						
61	Set the Attempts Lockout Time	<table style="display: inline-table; border-collapse: collapse;"><tr><td style="border: 1px solid black; width: 20px; height: 15px;"></td><td style="border: 1px solid black; width: 20px; height: 15px;"></td></tr><tr><td style="text-align: center; font-size: 8px;">(1)</td><td style="text-align: center; font-size: 8px;">(5)</td></tr></table> 1-60 seconds Seconds			(1)	(5)
(1)	(5)					
64/65	Remote Input Disable/Enable	Enable [ ] Disable [ ] (Enable)				
66	Ambush Code	<table style="display: inline-table; border-collapse: collapse;"><tr><td style="border: 1px solid black; width: 20px; height: 15px;"></td><td style="border: 1px solid black; width: 20px; height: 15px;"></td></tr><tr><td style="text-align: center; font-size: 8px;">(9)</td><td style="text-align: center; font-size: 8px;">(9)</td></tr></table> 01-99 Ambush Code			(9)	(9)
(9)	(9)					
67	Add Relay Function	[ ] 1. Remote Input switch closed and Function 65 Remote Input enabled. [ ] 2. Remote Input switch closed and Function 64 Remote Input disabled. [ ] 3. Failed attempted entry. [ ] 4. Disabled User or Group. [ ] 5. Follow Access Granted. [ ] 6. Group 1 User Code. [ ] 7. Scheduled Lock Event. [ ] 8. Scheduled Unlock Event. [ ] 9. Lock Out. [ ] 10. Ambush. [ ] 11. First Key Press.				
69/70	Enter Key Enable/Disable	Enable [ ] Disable [ ] (Disable)				





# Glossary

**ACCESS** = Entry into a restricted area.

**AMBUSH** = A special Code entered at the keypad when the User is forced to unlock a device. The device unlocks but sends a silent alarm with no indication at the lock keypad. Can be used to trip a relay, to alert security, or trip a silent alarm on a Burglary Control Panel.

**AUDIT TRAIL** = A date/time stamped log of previous lock events.

**BURGLARY CONTROL PANEL** = Provides local alarm and remote communication to request security for burglary/break-in. A DL3000 relay output used for Ambush can provide a silent alarm and call-for-help.

## CLOCK

- **REAL TIME CLOCK** = An accurate built-in clock that allows date/time stamping of events. The clock can be slowed or speeded up to fine tune long term accuracy to within three minutes per year.
- **CLOCK SETTINGS** = Printout includes date, time, weekday, and clock speed.
- **CLOCK SPEED** = The clock can be adjusted to allow faster/slower speeds and therefore increasing clock accuracy.

**CODE** = Numeric sequence of numbers (such as: 1234) entered at the keypad. If Star-Enter-Key is required, must be followed by a  key.

- **AMBUSH CODE** = See Ambush.
- **BASIC USER CODE** = User Codes assigned to User Numbers 12+ (except Users 299-300). (Basic User Codes do not allow programming)
- **INVALID CODE** = A User Code that has not been programmed in the lock.
- **MANAGER CODE** = User Codes assigned to User Numbers 2 through 6. (Allows most programming functions).
- **MASTER CODE** = The User Code assigned to User Number 1. The Default (factory) Master Code is 123456. The User with the Master Code has complete control of the lock (no programming restrictions).
- **SERVICE CODE** = User 300 User Code. Allows only one use, then must be re-enabled by Function 9.
- **SUPERVISOR CODE** = User Codes assigned to Users 7 through 11. Can only program certain day-to-day operational functions.
- **USER CODE** = Code used by Users. A User Code is 3 to 6 numeric digits long, pressed into the keypad buttons, allowing controlled entry by Users.
- **VALID CODE** = An entered User Code that has been programmed in the Lock Program.

**COM PORT** = A computer serial communications port used to communicate with the Lock and/or Data Transfer Module.

**DATA TRANSFER MODULE** = A device that permits transfer of program/data between a computer and the lock.

**DATE** = Month, Day and Year entered as MMDDYY.

**DAY OF WEEK** = Sunday through Saturday (where 1 = Sunday and 7 = Saturday).

**DEFAULT** = Default settings are the original settings that were set at the factory; in other words, it is the lock's original factory condition when the lock was first taken out of its original box. The default settings are permanently encoded within the lock's fixed memory, and when the lock is first started, or when power is removed and re-applied (see Wiring, Power-Up & Battery Replacement, page 10), the original factory default settings are re-loaded and take effect.

**DISABLE** = Turn off.

**DOOR NUMBER** = Identification of each door lock with a specific number in order to ensure that the correct lock is associated with the correct lock programming within DL-Windows or the AL-DTM.

**Note:** "Door Number" is a term used with AL-DTM versions 1 and 2 and with DL-Windows versions 3.5.0 and earlier. Later versions of the AL-DTM and DL-Windows monitor door numbers automatically, therefore there is no need to manually change door numbers via the keypad. Therefore, Function 59 is no longer used with the later versions of the AL-DTM and DL-Windows.

**DOWNLOAD** = To receive data from the lock into the AL-DTM or DL-Windows.

**ENABLE** = Turn on.

**EVENTS** = Recorded lock activity.

**FUNCTION** (also called **Programming Functions**) = are the numbers used to program lock features (enabling/disabling Users, User Groups, Passage Mode, Schedules, etc.).

## GROUP

- **USER GROUP** = Defining a User to specific Groups, allows User entry when the Group is allowed entry.
- **GROUP 1 ENABLES GROUP 4 USERS** = A Group 1 USER CODE entry during a predefined schedule will allow access to Group 4 Users. See page 26.
- **GROUP 1 PUTS UNIT IN PASSAGE** = A Group 1 USER CODE entry during a pre-defined schedule will unlock unit. See page 25.

**INSTALLER** = See.... CODE, INSTALLER CODE.

**KEYPAD** = 10-numeric keys,  and special  key.

- **KEYPAD LOCKOUT** = Keypad is programmed to lockout Users, for a specified period of time, when a specified number of invalid User Codes are entered.



## Glossary (cont'd)

- **KEYPAD PROGRAMMING** = Ability to program the lock through the keypad.

**KEYPRESS** = Pressing a button on the lock's keypad.

**LEVEL ABILITY** = Predefined User Types (such as Master, Manager and Supervisor) each having specific abilities to program and/or control the lock.

**LOCK PROGRAM** = A Lock Program is stored within the lock's circuitry and contains the instructions that the lock uses to perform its various functions. You can use the keypad to change the Lock Program, and you can also use DL-Windows to create a Lock Program on your computer, and then transfer and store the Lock Program within the lock.

**LOCKOUT ATTEMPTS** = A specified number of invalid User Code entries (1-9), that will disable the keypad for a predefined period of time (1-60 seconds).

**LOCKOUT TIME** = A predefined time (1-60) seconds that the lock will stop accepting User Codes, after a specified number of invalid User Code entries (1-9).

**LOG** = See... AUDIT TRAIL.

**MANAGER** = See... CODE, MANAGER CODE.

**MASTER** = See... CODE, MASTER CODE.

**PASSAGE** = Allow anyone to pass through the door without USER CODES (lock remains unlocked thus allowing passage).

**PRINTER** = A printout device such as an infrared printer or computer printer.

**PROGRAM MODE** = A mode allowing program/data to be entered through the keypad. Only specific Users (Master, Managers and Supervisors) can program a lock manually, by entering their USER CODE, followed by the  key.

**PROGRAMMABLE RELAY FUNCTIONS** = The relay can be programmed for one or more functions.

**RELAY** = Switched output allowing remote control of other devices. For an explanation of all relay features, see Function 67 on page 23.

**REMOTE INPUT** = Entry into a restricted area, by pressing a button connected to the REMOTE INPUT WIRES (White and White) by someone on the other side of the door.

**SCHEDULE** = A programmed operation (enable/disable, lock/unlock, etc.) on a specific day (Sunday through Saturday) and time.

**SCHEDULES, QUICK** = Any one of four most common types of schedules can be programmed.

**TIME** = Hours and Minutes in the HHMM format.

**TIME/DATE STAMP** = A recorded date and time that an event occurred.

**TIMEOUT** = Immediate operation for a specified number of hours.

**UPLOAD** = To send data from the AL-DTM or DL-Windows to the lock .

**USER** = A person who has been provided with a USER CODE for access through the door.

**USER LOCKOUT, TOTAL** = All User Codes have been disabled, thus "locking out" all Users (except for Master Code).

# NOTES

# NOTES

## ALARM LOCK LIMITED WARRANTY

ALARM LOCK SYSTEMS, INC. (ALARM LOCK) warrants its products to be free from manufacturing defects in materials and workmanship for 36 months following the date of manufacture. ALARM LOCK will, within said period, at its option, repair or replace any product failing to operate correctly without charge to the original purchaser or user.

This warranty shall not apply to any equipment, or any part thereof, which has been repaired by others, improperly installed, improperly used, abused, altered, damaged, subjected to acts of God, or on which any serial numbers have been altered, defaced or removed. Seller will not be responsible for any dismantling or reinstallation charges.

THERE ARE NO WARRANTIES, EXPRESS OR IMPLIED, WHICH EXTEND BEYOND THE DESCRIPTION ON THE FACE HEREOF. THERE IS NO EXPRESS OR IMPLIED WARRANTY OF MERCHANTABILITY OR A WARRANTY OF FITNESS FOR A PARTICULAR PURPOSE. ADDITIONALLY, THIS WARRANTY IS IN LIEU OF ALL OTHER OBLIGATIONS OR LIABILITIES ON THE PART OF ALARM LOCK.

Any action for breach of warranty, including but not limited to any implied warranty of merchantability, must be brought within the six months following the end of the warranty period. IN NO CASE SHALL ALARM LOCK BE LIABLE TO ANYONE FOR ANY CONSEQUENTIAL OR INCIDENTAL DAMAGES FOR BREACH OF THIS OR ANY OTHER WARRANTY, EXPRESS OR IMPLIED, EVEN IF THE LOSS OR DAMAGE IS CAUSED BY THE SELLER'S OWN NEGLIGENCE OR FAULT.

In case of defect, contact the security professional who installed and maintains your security system. In order to exercise the warranty, the product must be returned by the security professional, shipping costs prepaid and insured to ALARM LOCK. After repair or replacement, ALARM LOCK assumes the cost of returning products under warranty. ALARM LOCK shall have no obligation under this warranty, or otherwise, if the product has been repaired by others, improperly installed, improperly used, abused, altered, damaged, subjected to accident, nuisance, flood, fire or acts of God, or on which any serial numbers have been altered, defaced or removed. ALARM LOCK will not be responsible for any dismantling, reassembly or reinstallation charges.

This warranty contains the entire warranty. It is the sole warranty and any prior agreements or representations, whether oral or written, are either merged herein or are expressly cancelled. ALARM LOCK neither assumes, nor authorizes any other person purporting to act on its behalf to modify, to change, or to assume for it, any

other warranty or liability concerning its products.

In no event shall ALARM LOCK be liable for an amount in excess of ALARM LOCK's original selling price of the product, for any loss or damage, whether direct, indirect, incidental, consequential, or otherwise arising out of any failure of the product. Seller's warranty, as hereinabove set forth, shall not be enlarged, diminished or affected by and no obligation or liability shall arise or grow out of Seller's rendering of technical advice or service in connection with Buyer's order of the goods furnished hereunder.

ALARM LOCK RECOMMENDS THAT THE ENTIRE SYSTEM BE COMPLETELY TESTED WEEKLY.

Warning: Despite frequent testing, and due to, but not limited to, any or all of the following; criminal tampering, electrical or communications disruption, it is possible for the system to fail to perform as expected. ALARM LOCK does not represent that the product/system may not be compromised or circumvented; or that the product or system will prevent any personal injury or property loss by burglary, robbery, fire or otherwise; nor that the product or system will in all cases provide adequate warning or protection. A properly installed and maintained alarm may only reduce risk of burglary, robbery, fire or otherwise but it is not insurance or a guarantee that these events will not occur. CONSEQUENTLY, SELLER SHALL HAVE NO LIABILITY FOR ANY PERSONAL INJURY, PROPERTY DAMAGE, OR OTHER LOSS BASED ON A CLAIM THE PRODUCT FAILED TO GIVE WARNING. Therefore, the installer should in turn advise the consumer to take any and all precautions for his or her safety including, but not limited to, fleeing the premises and allig police or fire department, in order to mitigate the possibilities of harm and/or damage.

ALARM LOCK is not an insurer of either the property or safety of the user's family or employees, and limits its liability for any loss or damage including incidental or consequential damages to ALARM LOCK's original selling price of the product regardless of the cause of such loss or damage.

Some states do not allow limitations on how long an implied warranty lasts or do not allow the exclusion or limitation of incidental or consequential damages, or differentiate in their treatment of limitations of liability for ordinary or gross negligence, so the above limitations or exclusions may not apply to you. This Warranty gives you specific legal rights and you may also have other rights which vary from state to state.